

Campeche Chair Leg Patterns

Each pair of $\frac{1}{4}$ " hardboard templates can be held together with double-sided tape while you're making them. Before pulling them apart, there's one more thing to do. It's critical that you use a square to mark the locations of the half laps on the edges of the templates.

*NOTE: Print patterns
with printer set to
"actual" size*

**BACK
STILE**

1

**FRONT
STILE**

RED- Pattern
alignment line

Woodsmith No. 253
Online Extras Pg 1 of 8
©2021 Active Interest
Media Holding Co.
All rights reserved.



2

**BACK
STILE**

**FRONT
STILE**

*NOTE: Mark half lap locations
before pulling templates apart*

RED- Pattern
alignment line

Half lap

*NOTE: Mark half lap locations
before pulling templates apart*

Half lap

**BACK
STILE**

**FRONT
STILE**

Half lap

3

RED- *Pattern
alignment line*

Woodsmith No. 253
Online Extras Pg 3 of 8
©2021 Active Interest
Media Holding Co.
All rights reserved.



**BACK
STILE**

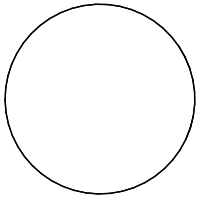

**FRONT
STILE**

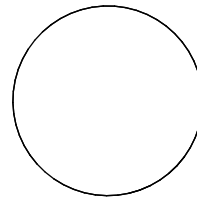

4

*NOTE: Print patterns
with printer set to
"actual" size*

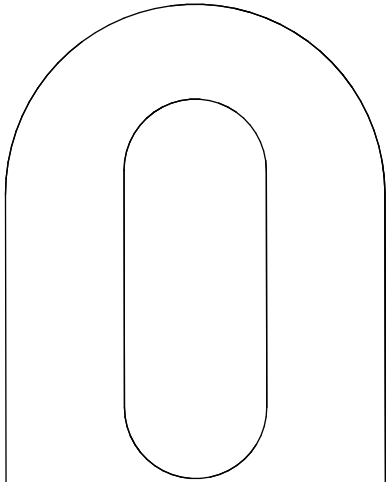

**FRONT
STILE**

5

**BACK
STILE**

RED- Pattern
alignment line

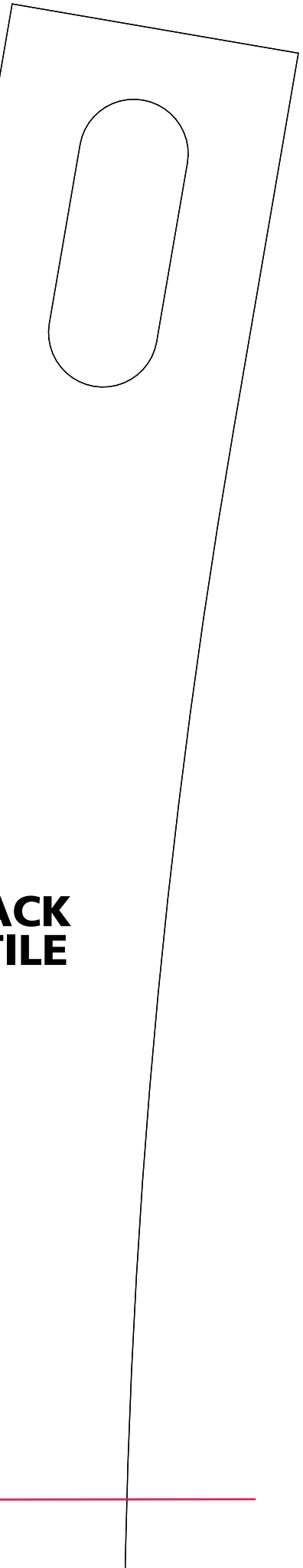

**FRONT
STILE**

**BACK
STILE**

6

Half lap

*NOTE: Mark half lap locations
before pulling templates apart*

RED- Pattern
alignment line

Woodsmith No. 253 Online Extras Pg 6 of 8
©2021 Active Interest Media Holding Co.
All rights reserved.

Half lap

Woodsmith No. 253 Online Extras Pg 7 of 8
©2021 Active Interest Media Holding Co.
All rights reserved.

**FRONT
STILE**

Half lap

NOTE: *Mark half lap locations
before pulling templates apart*

7

Half lap

**BACK
STILE**

RED- *Pattern
alignment line*



**FRONT
STILE**

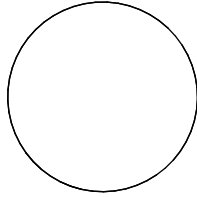

**BACK
STILE**

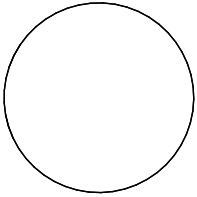

**HALF-LAP
ROUTING JIG**

*NOTE: Rails made
from 1/2" softwood*

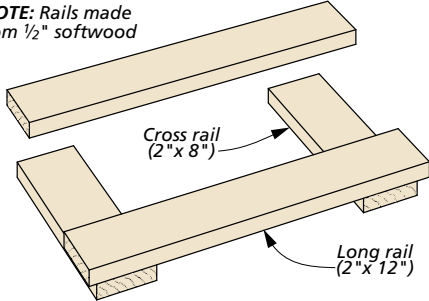

8

