

Counter-height Stool Patterns

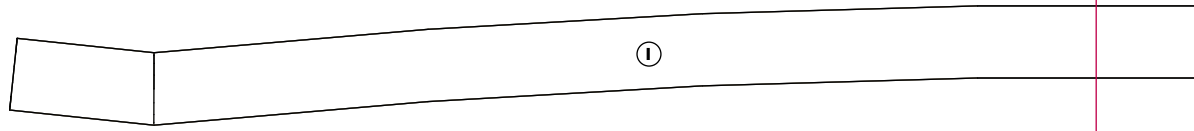

1

*NOTE: Print patterns with
printer set to "actual" size*

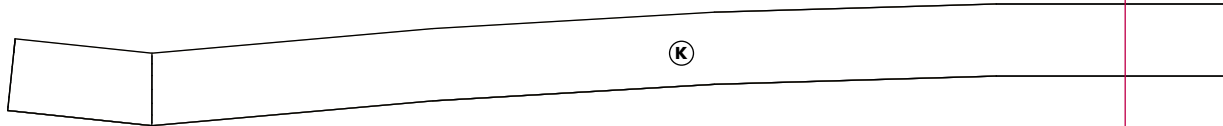
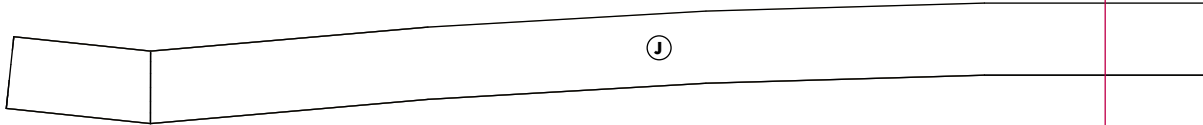

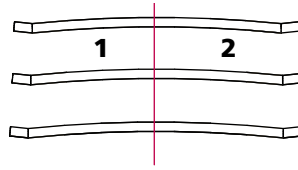

NOTE: Align patterns at red line

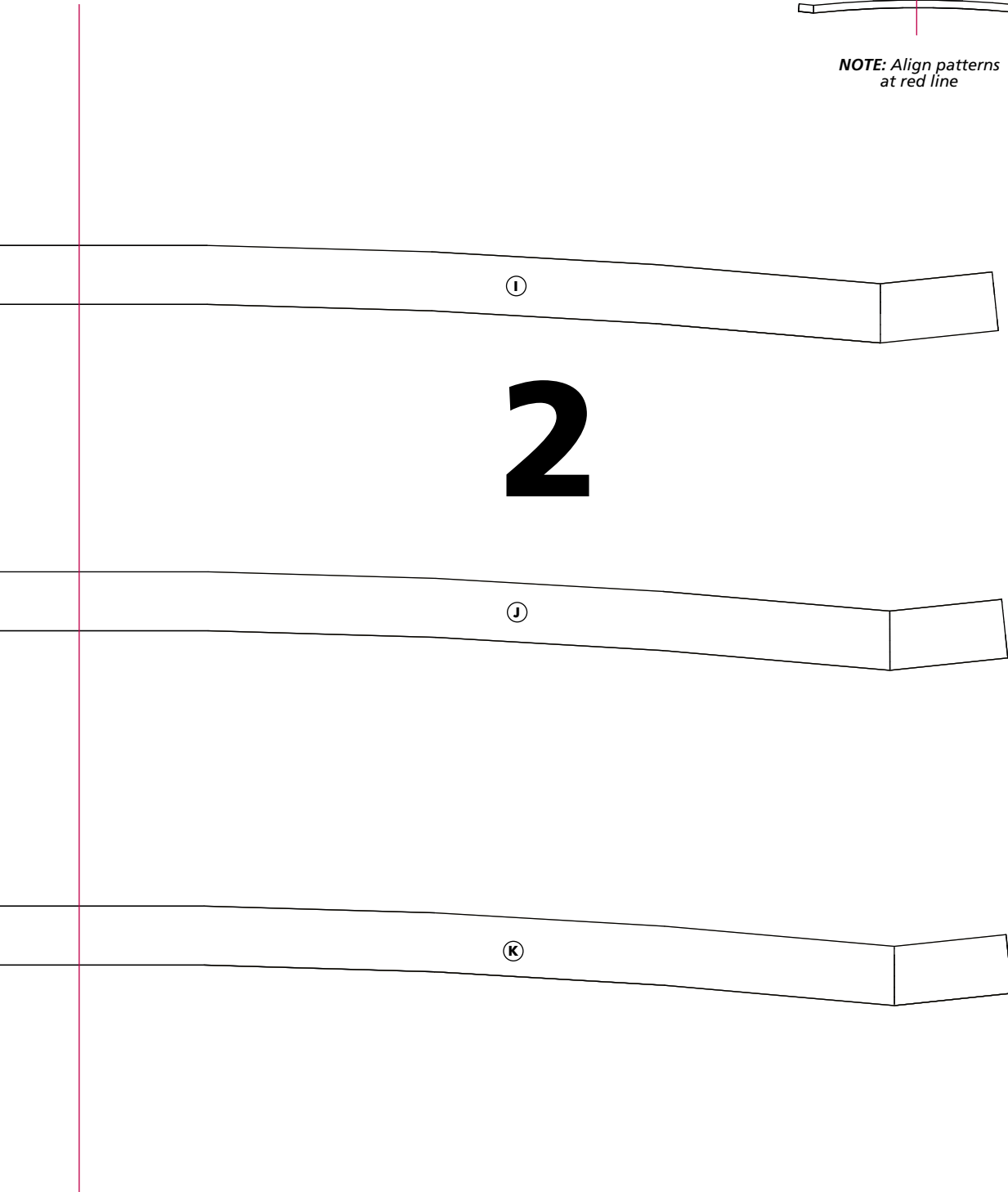

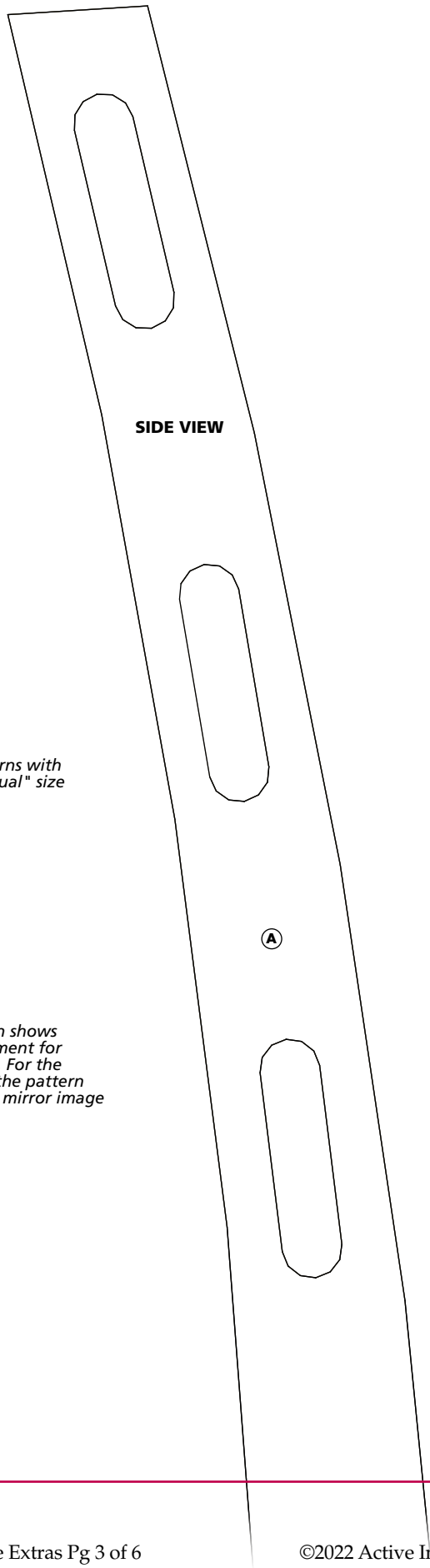

NOTE: Print patterns with printer set to "actual" size

NOTE: This pattern shows the mortise placement for the back right leg. For the back left leg, flip the pattern around to use the mirror image

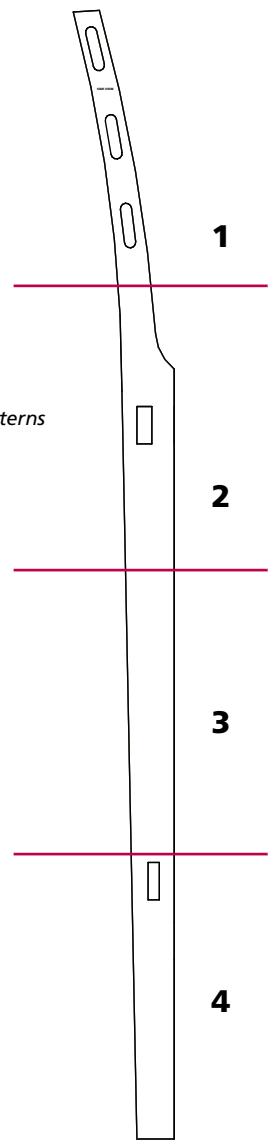

NOTE: Align patterns at red lines

1

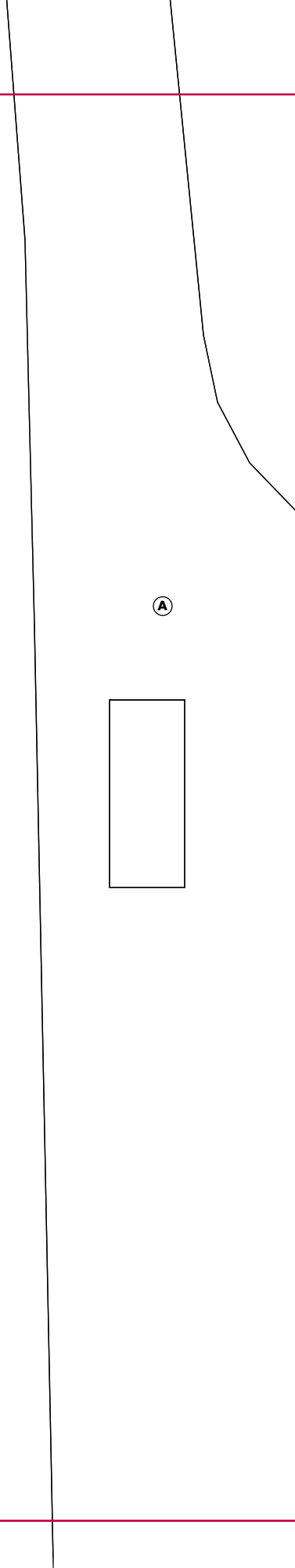

2

Ⓐ

3

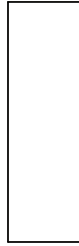

Ⓐ

4